

General Information

Terms & Conditions	GI-1 - GI-5
RGA Policy	GI-4
Product Modification	GI-5
Limited Warranty	GI-6 - GI-7
Finishes	GI-8
Merchandising Aids	GI-9
Weight Charge - Screw Substitutions	GI-10
Master Prefix Listing	GI-11 - GI-15
Business Hours & Holiday Schedule	GI-16
Who's Who at Sargent	GI-17 - GI-20
Ordering Tips	GI-21 - GI-23
Order Forms	GI-24 - GI-36

Cylinders & Keying

How to Order / Key Control Types	CK-1
Keying Charges	CK-2 - CK-3
Key Charts, Key Wizard Software	CK-4
Mortise, Rim Cylinders & Parts	CK-5
Rings, Turn Knobs & Mail Box Cylinders	CK-6
Cylindrical Lock Cylinders & Parts	CK-7
SARGENT XC Series Cylinders	CK-8 - CK-9
SARGENT Large Format Interchangeable Core Cylinders & Old Style Removable Core Cylinders	CK-10
SARGENT XC - Large Format IC Core Cylinders	CK-11
Small Format Interchangeable Core	CK-12
XC - Small Format Interchangeable Core	CK-13
Keying Kits, Tools, Gauges, Components	CK-14
Keyblanks	CK-15 - CK-16
SARGENT Cut Keys/Competitor Keyways	CK-17
KESO F1 Security System	CK-18 - CK-22
KESO System	CK-23 - CK-27
Signature Key System	CK-28 - CK-31

Bored Locks

How to Order / ANSI Finish & Function Comparison	BL-1
T-Zone (11 Line)	BL-2 - BL-21
10 Line	BL-22 - BL-33
7 Line	BL-34 - BL-41
7500 Line	BL-42 - BL-43
6500 Line	BL-44
GX (3 Line)	BL-45
DL Series	BL-46 - BL-51
RDL Series	BL-52 - BL-53
8 Line	BL-54 - BL-61
6 Line	BL-62 - BL-65
5500 Line	BL-66

Mortise Locks 7800/8200

How to Order / ANSI Finish & Function Comparison	ML-1
8200 Line (levers)	ML-2 - ML-37
7800 Line (Knobs)	ML-38 - ML-49
8200 Deadlocks	ML-50
Distributor Bulk Pack Trim Program	ML-51 - ML-54

7800/8200 Lockbodies	ML-55
7800/8200 Working Trim Sets	ML-56 - ML-67
7800/8200 Assemblies & Parts	ML-68 - ML-80
How to Order / ANSI Finish & Function Comparison	ML-81
7900 Mortise Lock	ML-82 - ML-105

High Security Mortise Lock 9200

How to Order - ANSI Finish & Function Comparison	ML-107
9200 & M9200 - Levers	ML-108 - ML-115
9200 & M9200 - Knobs	ML-115 - ML-121
9200 Deadlock, Lockbodies	ML-122
9200 Parts	ML-123
9200 Inside Trim Set	ML-124
9200 Outside Trim Set	ML-125

Multipoint Locking Hardware

How to Order - ANSI Finish & Function Comparison	MP-1
7000 Series	MP-2 - MP-3
NB7000 Series	MP-4 - MP-5
WD7000 Series	MP-6 - MP-7
ER/ES/ET Lever Control Trim	MP-8 - MP-9
7000 Strikes, Locking Slide & Spindle Kits	MP-10
Parts	MP-11
FM6100 Series	MP-12 - MP-13
FM7100 Series	MP-14 - MP-15

Door Closers/ Holders & Stops

How to Order / ANSI Finish & Function Comparison	DC-1
Additional Features	DC-2
1431 / 281 / 351 Series	DC-3
268, 269, 281 Security Package Closer	DC-4
421 Cam Action Door Closer	DC-4
268, 269, 278 Concealed Closers	DC-4
Finish Options	DC-5
Arms & Accessories	DC-6
Bodies/Covers/Retrofit Kits	DC-7
1331 / 1130 Series	DC-8
Parts	DC-9 - DC-10
Overhead Holders & Stops	HS-1
Door Holders	HS-2
Electromagnetic Holders & Stop	HS-3

Exit Devices

How to Order - ANSI Finish & Function Comparison	ED-1
20 Series	ED-2 - ED-3
30 Series	ED-4 - ED-5
9898 Reversible Stocking Exit	ED-6 - ED-7
80 Series	ED-8 - ED-39
9400 Series	ED-40 - ED-41
90 Series	ED-42 - ED-47
Trim	ED-48 - ED-51
8893/8895 Inactive & Active Push Bars	
Mullions & Accessories	ED-52 - ED-57
Parts	ED-58 - ED-68
P Series Exit Device	ED-70 - ED-75

TOC-2

TABLE OF CONTENTS

SARGENT®

ASSA ABLOY

January 1, 2011 | Minimum Order \$250

Auxiliary Locks

460-470 SSL1 Series	AL-1
480 Series	AL-2
4870 Series	AL-3
460-480-4870 Strikes & Parts	AL-4
4870 Parts	AL-5
Locker, Utility, & Cabinet Locks	AL-6
858 Padlock & Parts	AL-8

Specialty Hardware

HP Series Tubular Lock with Push/Pull (ALP) Trim & Options	SP-1
114/115 Series with Push/Pull Trim & Options	SP-2
114/115 Push/Pull Parts	SP-3
8200 Series PUSH/PULL Trim (ALP) Options	SP-4
8200 Series PUSH/PULL Trim (ALP)	SP-5
7800 Series Push/Pull Trim(PT) Options	SP-6
7800 Series Push/Pull Trim(PT)	SP-7

Electrical

Electro-Mechanical Locksets	EL-1
Electro-Mechanical Exits	EL-2
ElectroLynx / Wiring Diagram Service	EL-3
Electronic Accessories	EL-4 - EL-7
Alarms - 540/550/5100/5800	EL-8 - EL-9
Fire Guard Door Closers	EL-10 - EL-11
M Power Low Energy Door Operator	EL-12 - EL-13
Parts	EL-14 - EL-15

Profile Series - Stand Alone Products

How to Order / ANSI Finish & Function Comparison	PS-1
10 Line Cylindrical Lock - KP, G1, RF	PS-2 - PS-3
8200 Series Mortise Lock - KP, G1, RF	PS-4 - PS-7
80 Series - Exit Device - KP, G1, RF	PS-8 - PS-9
Accessories	PS-10
Parts & Accessories	PS-11
10 Line Parts & Accessories	PS-12
8200 Series Parts & Accessories	PS-13 - PS-14
80 Series Trim & Trim Kits	PS-15
80 Series Parts & Accessories	PS-16

GENERAL INFORMATION

Terms and Conditions.....	GI-1
Terms and Conditions.....	GI-2
Terms and Conditions.....	GI-3
Terms and Conditions.....	GI-4
Terms and Conditions.....	GI-5
Limited Warranty	GI-6
Limited Warranty	GI-7
Finishes	GI-8
Merchandising Aids	GI-9
Weight Chart - Screw Substitutions	GI-10
Master Option Listing (1-26).....	GI-11
Master Option Listing (28-65737P)	GI-12
Master Option Listing (68-83).....	GI-13
Master Option Listing (84-SC).....	GI-14
Master Option Listing (SE-WS).....	GI-15
Business Hours, Holiday Schedule, Website Information.....	GI-16
Who's Who at SARGENT.....	GI-17
Who's Who at SARGENT.....	GI-18
Who's Who at SARGENT.....	GI-19
Who's Who at SARGENT.....	GI-20
Ordering Tips and SARGENT Key Systems Security Policy	GI-21
Ordering Tips and Keying Authorization Documentation	GI-22
Ordering Tips.....	GI-23
SARGENT Order Lead Sheet Check List	GI-24
Keying Order Form.....	GI-25
Keying Order Form.....	GI-26
Keying Order Form.....	GI-27
Locksets Order Form.....	GI-28
Exit Devices Order Form.....	GI-29
Door Closers Order Form.....	GI-30
Miscellaneous Items Order Form	GI-31
Signature Series Order Form	GI-32
KESO Authorized Signature Form	GI-33
KESO Authorization Form	GI-34
KESO 24 Hour Key Order Form	GI-35
Key Wizard™ Registration Form.....	GI-36

8700 SERIES OPTIONS





January 1, 2011 | Minimum Order \$250

Options	Description	Price
10	SARGENT Signature System	\$37.00 / cyl.
10UL	SARGENT Signature Cylinder meeting UL437 (Mortise & Rim Cylinders only)	\$52.00 / cyl.
11	SARGENT XC Key System (not available w/10, 10UL, 22, 60, 63, 64, KESO, SC, SE)	No addition
1160	SARGENT XC Large Format Interchangeable Plastic Disposable Construction Core	No addition
1163	SARGENT XC Large Format Interchangeable Core Cylinder – Includes masterkeying charges	\$48.00
1164	SARGENT XC Large Format Interchangeable Construction Core Cylinder	See CK-2
1170	Small Format interchangeable disposable construction core - to accept 7 Pin XC permanent core	No addition
11727P	Small Format interchangeable keyed construction core - to accept 7 Pin XC permanent core	See CK-2
11737P	Small Format interchangeable core - to accept 7 pin XC permanent core	\$44.00 / cyl.
12	UL Fire Label Exit Devices (not available with 16- & HK options)	\$137.00
14	Sliding bolt bottom case for 8700 Series	No addition
16	Cylinder lockdown feature in rail (not available with 12-, 57-, 59-, AL-, & BT- options)	\$103.00
19	80 Series pushbar without Lexan touchpad	No addition
21	SARGENT Construction Key System (lost ball)	\$12.00 / cyl.
22	SARGENT Construction Key System (split key)	\$12.00 / cyl.
31	For doors greater than 1 3/4" and up to 2 1/4" (including those with auxiliary controls)	No addition
	For doors over 2-1/4"	Consult Factory
	For doors with panels	Consult Factory
36	6 Lobe security head screws	\$74.00
37	Spanner head screws	\$49.00
43	Flush End Cap	No addition
* 53	Latchbolt Monitor Switch – available with 55, 56, 57, 58, AL options – not available with NB	\$198.00
54	Internal Micro Switch in ET Control	\$198.00
* 55	Signal Switch in Rail	\$198.00
* 56	Remote Dogging / Latch Retraction (Minimum door width for narrow stile is 26" and wide stile is 28")	\$835.00
* HK56	Latch Retraction with Hex Key Dogging	\$835.00
* 57	Delayed Action (Magnet ordered separate)	\$1,252.00
* 58	Electric Dogging	\$405.00
* 59	Electroguard (Not available with 16-, 55-, 56-, 57-, 58- Options)	\$1,335.00
* BC59	Electroguard Boca Code (Needs Door Status Switch) (Not available with 16-, 55-, 56-, 57-, 58- Options)	\$1,426.00
60	SARGENT Large Format Interchangeable Plastic Disposable Construction Core	No addition
63	SARGENT Large Format Interchangeable Core Cylinder includes master and grandmaster keying charge	\$48.00 / cyl.
64	SARGENT Large Format Interchangeable Construction Core Cylinder	See CK-2
6573	Small Format 6 Pin Uncombined Core	\$34.00 / cyl.
65737P	Small Format 7 Pin Uncombined Core	\$34.00 / cyl.
70	Small Format Interchangeable Disposable plastic construction core	No addition
72	Small Format Interchangeable 6-Pin Construction Core (7-pin with 11 option)	See CK-2
73	Small Format 6-pin interchangeable core	\$44.00 / cyl.
737P	Small Format 7-pin interchangeable core	\$44.00 / cyl.
76	Tactile Warning - Milled Outside Lever (Not available with Studio, Coastal and the A Levers)	\$61.00
81	Cylinder to accept Keso (83) and Keso F1 (F183) removable core – no core provided	No addition
F182	SARGENT Keso Security, patent pending, cylinder – new key systems	\$51.00 / cyl.
F183	SARGENT Keso Security, patent pending, removable core cylinder – new key systems	\$73.00 / cyl.
82	SARGENT Keso Security Cylinder (existing key systems only)	\$51.00 / cyl.
83	SARGENT Keso Security Removable Core Cylinder (existing key systems only)	\$73.00 / cyl.
84	SARGENT Keso Security Removable Construction Core Cylinder	See CK-18
85	Tactile Warning - Abrasive Strip Inside Push Rail	\$77.00
86	Tactile Warning - Abrasive Coating Outside Lever	\$36.00
87	Tactile Warning - Abrasive Strip on Inside Push Rail & Coating on Outside Lever	\$113.00
* AL	Alarmed (not available with HC, 16, 56 thru 59 options)	\$473.00
BR	SARGENT Bump Resistant Cylinders (N/A w/10, 22, 30, 60, 63, 64, 70, 72, 73, 737P, KESO, SC, SE)	\$20.00 / cyl.
BT	SARGENT Beacon™ Safe Egress (N/A with 16, 56, 57, 59, BC59, AL options)	\$1,030.00
CPC	Clear Powder Coat – Recommended for exit devices used in full exterior application and highly corrosive areas with 32 and 32D finishes. Discount Do Not Apply	\$108.00
HC	Hurricane Code (available with 06, 10, 13, 15, 40, 43 functions only)	\$110.00
12HC	UL Fire Label Hurricane Code (available with 06, 10, 13, 15, 40, 43 functions only)	\$247.00
LC	Less Cylinder	-\$58.00/cyl.
LD	Less Dogging	No addition
PL	SARGuide™ PL – Photoluminescent Coating – (Pushbar w/o Lexan Touchpad - 19 option is supplied as standard)	\$293.00
SC	Schlage C Keyway Cylinder 0-Bitted (Rim and #41 Mortise Cylinder Only)	No addition
SE	Schlage E Keyway Cylinder 0-Bitted (Rim and #41 Mortise Cylinder Only)	No addition
SG	MicroShield™ an antimicrobial powder coat (not available with 10B)	\$57.00
TB	Thru Bolt	\$63.98
* TL	SARGuide™ – Illuminated Touchpad (not available with AL, 57, 59 options)	\$214.00

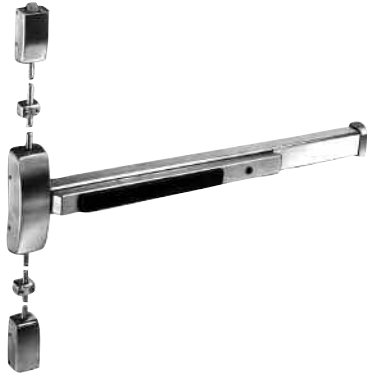
*** Exact door width required when ordering.**

Vertical Rod Device to 96" Height	No addition
Concealed/Surface Vertical Rod Device over 96" to 120" Height	\$52.00
Refer to catalog for max. door height availability on fire rated exit devices.	



8700 Series-Surface Vertical Rod Device			
 ET Control Standard Levers: A-B-E-F-J-L-P-W Coastal Levers: C-G-R-S-Y All Studio Collection Levers (Except Gramercy Series)	 ET Control Gramercy Series: RAG-RAL-RAM-RAS- RAW-RCM-REM-RGM	 PTB STS-MAL-FLL-FLW	  306/313 Auxiliary Control with 862, 863 864 Pull Price includes 862 Pull (shown)
Finishes listed below are for the exit device. Refer to catalog for available trims, trim finishes and how to order.			

8700 Series	Function Description	Finish							
		10, 10B, 32D	3, 4, 9, 10BL, 20D, 32	10, 10B, 32D	3, 4, 9, 10BL, 20D, 32	10, 10B, 32D	3, 4, 9, 10BL, 20D, 32	10, 10B, 32D	3, 4, 32
8710	Exit Only - No Trim	\$1,524.00	\$1,611.00						
8710	Dummy Trim (Lever rigid)	\$1,979.00	\$2,066.00	\$2,133.00	\$2,220.00	\$1,800.00	\$1,887.00	\$1,701.00	\$1,801.00
*8710	Key operates control							\$2,156.00	\$2,256.00
8706	Key operates ET								
8713	Key locks/unlocks ET	\$1,979.00	\$2,066.00	\$2,133.00	\$2,220.00				
8715	Trim always operable								
8728	Thumb pc.always operable								
8762	Key operates Thumb piece					\$1,876.00	\$1,963.00		
8763	Key Locks/unlocks Thumb pc.								

*When ordering Exits with Auxiliary Control Design, please order as follows: example: 8710F x 306/313 x 862 x 32D x RHR

8700 Series With Freewheeling Trim									
8740	Dummy Trim (Lever rotates)								
8743	Key engages/disengages lever	\$1,979.00	\$2,066.00	\$2,133.00	\$2,220.00				
8746	Key operates control								
8700 Series With Electro-Mechanical									
8773	Fail Safe 12v or 24v	\$2,167.00	\$2,254.00	\$2,304.00	\$2,391.00				
8774	Fail Secure 12v or 24v								

Note: Specify voltage required when ordering.

863 (18" x 1" Diameter) Pull provided in lieu of 862 (10" x 1" Diameter) Add \$43.00

864 (10" x 3/4" Diameter) Pull provided in lieu of 862 (10" x 1" Diameter) Deduct \$24.00

► Dummy Trim includes pull only, Auxiliary Control not supplied.

Thru Bolt Application		No. Bolts per Pack	Pack Part #		Finish
			1-3/4" Dr.	2 1/4" Dr.	3,9,10,10B,10BL,20D,26D
8700	Rail & Chassis	4	68-2279	68-2280	\$18.28 Pack
8700	Cases & Guides	10	68-2282	68-2283	\$45.70 Pack
12-8700		16	68-2288	68-2289	\$73.12 Pack

NOTES:

Cylinders not included when ordered less trim.

15 or 26D finishes are available on outside trim only, the exit devices will be supplied in 32D.

14 or 26 Finishes are available on outside trim only, the exit devices will be supplied in 32 finish.

8800 SERIES OPTIONS





January 1, 2011 | Minimum Order \$250

Options	Description	Price
10	SARGENT Signature System	\$37.00 / cyl.
10UL	SARGENT Signature Cylinder meeting UL437 (Mortise & Rim Cylinders only)	\$52.00 / cyl.
11	SARGENT XC Key System (not available w/10, 10UL, 22, 60, 63, 64, KESO, SC, SE)	No addition
1160	SARGENT XC Large Format Interchangeable Plastic Disposable Construction Core	No addition
1163	SARGENT XC Large Format Interchangeable Core Cylinder – Includes masterkeying charges	\$48.00
1164	SARGENT XC Large Format Interchangeable Construction Core Cylinder	See CK-2
1170	Small Format interchangeable disposable construction core - to accept 7 Pin XC permanent core	No addition
11727P	Small Format interchangeable keyed construction core - to accept 7 Pin XC permanent core	See CK-2
11737P	Small Format interchangeable core - to accept 7 pin XC permanent core	\$44.00 / cyl.
12	UL Fire Label Exit Devices (not available with 16- & HK options)	\$137.00
16	Cylinder lockdown feature in rail (not available with 12-, 57-, 59-, AL-, & BT- options)	\$103.00
19	80 Series pushbar without Lexan touchpad	No addition
21	SARGENT Construction Key System (lost ball)	\$12.00 /cyl.
22	SARGENT Construction Key System (split key)	\$12.00 /cyl.
31	For doors up to 2-1/4"	No addition
	For doors over 2-1/4"	Consult Factory
	For doors with panels	Consult Factory
36	6 Lobe security head screws	\$40.00
37	Spanner head screws	\$27.00
43	Flush End Cap	No addition
* 53	Latchbolt Monitor Switch – available with 55, 56, 57, 58, AL options	\$198.00
54	Internal micro switch in ET control	\$198.00
* 55	Signal Switch in Rail	\$198.00
* 56	Remote Dogging / Latch Retraction (Minimum door width for narrow stile is 26" and wide stile is 28")	\$835.00
* HK56	Latch Retraction with Hex Key Dogging	\$835.00
* 57	Delayed Action (Magnet ordered separate)	\$1,252.00
* 58	Electric Dogging	\$405.00
* 59	Electroguard (Not available with 16-, 55-, 56-, 57-, 58-, HC Options)	\$1,335.00
* BC59	Electroguard Boca Code (Needs Door Status Switch) (Not available with 16-, 55-, 56-, 57-, 58- HC-options)	\$1,426.00
60	SARGENT Large Format Interchangeable Plastic Disposable Construction Core	No addition
63	SARGENT Large Format Interchangeable Core Cylinder includes master and grandmaster keying charge	\$48.00 /cyl.
64	SARGENT Large Format Interchangeable Construction Core Cylinder	See CK-2
6573	Small Format 6 Pin Uncombined Core	\$34.00 / cyl.
65737P	Small Format 7 Pin Uncombined Core	\$34.00 / cyl.
70	Small Format Interchangeable Disposable plastic core	No addition
72	Small Format Interchangeable Cores 6-Pin Construction Core provided (7-pin with 11 option)	See CK-2
73	Small Format 6-pin interchangeable core	\$44.00 / cyl.
737P	Small Format 7-pin interchangeable core	\$44.00 / cyl.
76	Tactile Warning - Milled Outside Lever (Not available with Studio, Coastal and the A Levers)	\$61.00
F182	SARGENT Keso Security, patent pending, cylinder – new key systems	\$51.00 / cyl.
F183	SARGENT Keso Security, patent pending, removable core cylinder – new key systems	\$73.00 / cyl.
81	Cylinder to accept Keso (83) and Keso F1 (F183) removable core – no core provided	No addition
82	SARGENT Keso Security Cylinder (existing key systems only)	\$51.00 / cyl.
83	SARGENT Keso Security Removable Core Cylinder (existing key systems only)	\$73.00 / cyl.
84	SARGENT Keso Security Removable Construction Core Cylinder	See CK-18
85	Tactile Warning - Abrasive Strip Inside Push Rail	\$77.00
86	Tactile Warning - Abrasive Coating Outside Lever	\$36.00
87	Tactile Warning - Abrasive Strip on Inside Push Rail & Coating on Outside Lever	\$113.00
* AL	Alarmed (not available with HC, 16, 56 thru 59 options)	\$473.00
BR	SARGENT Bump Resistant Cylinders (N/A w/10, 22, 30, 60, 63, 64, 70, 72, 73, 737P, KESO, SC, SE)	\$20.00 /cyl.
BT	SARGENT Beacon™ Safe Egress (N/A with 16, 56, 57, 59, BC59, AL, AL93 options)	\$1,030.00
CPC	Clear Powder Coat – Recommended for exit devices used in full exterior application and highly corrosive areas with 32 and 32D finishes. Discount Do Not Apply	\$108.00
GL	Guarded Latch (not available with HC or 12-HC)	\$28.00
HC	Hurricane Code (available with 04, 06, 10, 13, 15, 40, 43, 44, 75, 76 functions only)	\$67.00
12HC	UL Fire Label Hurricane Code (available with 04, 06, 10, 13, 15, 40, 43, 44, 75, 76 functions only)	\$204.00
LC	Less Cylinder	-\$58.00/cyl.
LD	Less Dogging	No addition
PL	SARGuide™ PL – Photoluminescent Coating – (Pushbar w/o Lexan Touchpad - 19 option is supplied as standard)	\$293.00
SC	Schlage C Keyway Cylinder 0-Bitted (Rim and #41 Mortise Cylinder Only)	No addition
SE	Schlage E Keyway Cylinder 0-Bitted (Rim and #41 Mortise Cylinder Only)	No addition
SG	MicroShield™ an antimicrobial powder coat (not available with 10B)	\$57.00
TB	Thru Bolt	\$18.28
* TL	SARGuide™ – Illuminated Touchpad (not available with AL, 57, 59 options)	\$214.00
WS	Windstorm Certified	No addition

8888 Device and Trims, see pg. ED-37.

* Exact door width required when ordering.



8800 Series-Rim Device			
 ET Control Standard Levers: A-B-E-F-J-L-P-W Coastal Levers: C-G-R-S-Y All Studio Collection Levers (Except Gramercy Series)	 ET Control Gramercy Series: RAG-RAL-RAM-RAS- RAW-RCM-REM-RGM	 PTB STS-MAL-FLL-FLW PSB-MSL-FSL-FSW (04 function only)	 Cylinder included on keyed functions. 862, 863, 864 Pull Price includes 862 Pull (shown)
Finishes listed below are for the exit device. Refer to catalog for available trims, trim finishes and how to order.			

8800 Series	Finish							
	10, 10B, 32D	3, 4, 9, 10BL, 20D, 32	10, 10B, 32D	3, 4, 9, 10BL, 20D, 32	10, 10B, 32D	3, 4, 9, 10BL, 20D, 32	10, 10B, 32D	3, 4, 32
Funct. Description								
8810 Exit Only – No Trim	\$1,108.00	\$1,166.00						
8810 Dummy Trim (Lever rigid)					\$1,384.00	\$1,442.00	\$1,285.00	\$1,356.00
8804 Key retr. latchbolt (lever rigid)								
8806 Key operates ET	\$1,563.00	\$1,621.00	\$1,717.00	\$1,775.00				
8813 Key locks/unlocks control								
8815 Trim always operable								
8816 Key i/s locks/unlocks lever Key o/s retracts latchbolt	\$1,690.00	\$1,748.00	\$1,844.00	\$1,902.00				
8828 Thumb piece always operable					\$1,457.00	\$1,515.00		
8863 Key locks/unlocks thumb piece								
8866 Key i/s locks/unlocks thumb pc. Key o/s retracts latchbolt					\$1,513.00	\$1,571.00		
8800 Series With Freewheeling Trim								
8840 Dummy Trim (Lever rotates)								
8843 Key engages/disengages lever	\$1,563.00	\$1,621.00	\$1,717.00	\$1,775.00				
8844 Key retr. litchblt. (Lever rotates)								
8846 Key operates ET								
8800 Series With Electro-Mechanical								
8873 Fail Safe 12v or 24v	\$1,751.00	\$1,809.00	\$1,888.00	\$1,946.00				
8874 Fail Secure 12v or 24v								
8875 Fail Safe 12v or 24v	\$1,905.00	\$1,963.00	\$2,042.00	\$2,100.00				
8876 Fail Secure 12v or 24v								

Note: Specify voltage required when ordering.

863 (18" x 1" Diameter) Pull provided in lieu of 862 (10" x 1" Diameter) Add \$43.00

864 (10" x 3/4" Diameter) Pull provided in lieu of 862 (10" x 1" Diameter) Deduct \$24.00

Thru Bolt Application	Pack Part #		Finish	
	No. Bolts per Pack	1-3/4" Dr.	2 1/4" Dr.	3,9,10,10B,10BL,20D,26D
8800, 12-8800	4	68-2279	68-2280	\$18.28 Pack

NOTES:

FLW, FSW not available in 32, 32D.

PSB, MSL, FSL, FSW for use with 8804 function only. Supplied with revised cylinder hole location and thru bolting.

Cylinder not included when ordered less trim except for 04 function.

15 or 26D finishes are available on outside trim only, the exit devices will be supplied in 32D.

14 or 26 Finishes are available on outside trim only, the exit devices will be supplied in 32 finish.